

MEDICATION GUIDE
FINTEPLA® (fin-TEP-la)
(fenfluramine)
oral solution

Read this Medication Guide before you start taking FINTEPLA and each time you get a refill. There may be new information. This information does not take the place of talking to your healthcare provider about your medical condition or treatment.

What is the most important information I should know about FINTEPLA?

FINTEPLA can cause serious side effects, including:

- 1. Problems with the valves in the heart (valvular heart disease) and high blood pressure in the arteries of the lungs (pulmonary arterial hypertension)** have been associated with fenfluramine, the active ingredient in FINTEPLA. Your healthcare provider will do a test called an echocardiogram to check your heart and for high blood pressure in the arteries of the lungs before you start taking FINTEPLA, again every 6 months during treatment, and one time 3 to 6 months after you take your last dose of FINTEPLA.

Call your healthcare provider right away if you develop any of these signs and symptoms of heart or lung problems during treatment with FINTEPLA:

- shortness of breath
- tiredness or weakness, especially with increased activity
- lightheadedness or fainting
- swollen ankles or feet
- chest pain
- sensations of a rapid, fluttering heartbeat (palpitations)
- irregular pulse
- bluish color to your lips and skin (cyanosis)

Because of the risk of heart valve problems (valvular heart disease) and high blood pressure in arteries of lungs (pulmonary arterial hypertension) FINTEPLA is only available through a restricted program called the FINTEPLA Risk Evaluation and Mitigation Strategy (REMS) Program. Before you or your child receives FINTEPLA, your healthcare provider or pharmacist will make sure you understand how to take FINTEPLA safely. If you have any questions about FINTEPLA, ask your healthcare provider, visit www.FinteplaREMS.com, or call 1-877-964-3649.

- 2. Decreased appetite and decreased weight.** Decreased appetite and decreased weight are both serious and common side effects of FINTEPLA in people with Dravet syndrome (DS) or Lennox-Gastaut syndrome (LGS).
- Your weight should be checked regularly during your treatment with FINTEPLA.
 - Your healthcare provider may need to make changes to your FINTEPLA dose if your weight decreases. In some cases, FINTEPLA may need to be stopped.

- 3. Sleepiness, sedation, and lack of energy (lethargy).** These are both serious and common side effects of FINTEPLA in people with Dravet syndrome (DS) or Lennox-Gastaut syndrome (LGS). Taking FINTEPLA with central nervous system (CNS) depressants including alcohol may increase sleepiness. **Do not** drive, operate heavy machinery, or do other dangerous activities until you know how FINTEPLA affects you.

- 4. Like all other antiepileptic drugs, FINTEPLA may cause suicidal thoughts or actions** in a very small number of people (about 1 in 500).

Call your healthcare provider right away if you have any of these symptoms, especially if they are new, worse, or worry you:

- thoughts about suicide or dying
- trouble sleeping (insomnia)
- attempts to commit suicide
- new or worse irritability
- new or worse depression
- acting aggressive, being angry, or violent
- new or worse anxiety
- acting on dangerous impulses
- feeling agitated or restless
- an extreme increase in activity and talking (mania)
- panic attacks
- other unusual changes in behavior or mood

How can I watch for early symptoms of suicidal thoughts and actions?

- Pay attention to any changes, especially sudden changes, in mood, behaviors, thoughts, or feelings.
- Keep all follow-up visits with your healthcare provider as scheduled.

Suicidal thoughts or actions can be caused by things other than medicines. If you have suicidal thoughts or actions, your healthcare provider may check for other causes.

- 5. Do not stop taking FINTEPLA without first talking to your healthcare provider.** Stopping a seizure medicine such as FINTEPLA suddenly can cause you to have seizures more often or seizures that do not stop (status epilepticus).

Call your healthcare provider between visits as needed, especially if you are worried about symptoms.

What is FINTEPLA?

- FINTEPLA is a prescription medicine used to treat the seizures associated with Dravet syndrome (DS) and Lennox-Gastaut syndrome (LGS) in patients 2 years of age and older.
- It is not known if FINTEPLA is safe and effective in children less than 2 years of age.

Do not take FINTEPLA if you:

- are allergic to fenfluramine or any of the ingredients in FINTEPLA. See the end of this Medication Guide for a complete list of ingredients in FINTEPLA.
- are taking or have stopped taking medicines called monoamine oxidase inhibitors (MAOI) in the last 14 days. This may cause a serious or life-threatening problem called **serotonin syndrome**. If you are not sure whether or not you are taking one of these medicines, contact your healthcare provider.

Before taking FINTEPLA, tell your healthcare provider about all of your medical conditions, including if you:

- have heart problems
- have or have had weight loss
- have or have had depression, mood problems, or suicidal thoughts or behavior
- have kidney problems
- have liver problems
- are pregnant or plan to become pregnant. Tell your healthcare provider right away if you become pregnant while taking FINTEPLA. You and your healthcare provider will decide if you should take FINTEPLA while you are pregnant.
 - If you become pregnant while taking FINTEPLA, talk to your healthcare provider about registering with the North American Antiepileptic Drug Pregnancy Registry. You can enroll in this registry by calling 1-888-233-2334 or go to www.aedpregnancyregistry.org. The purpose of this registry is to collect information about the safety of antiepileptic drugs during pregnancy.
- are breastfeeding or plan to breastfeed. It is not known if FINTEPLA passes into your breast milk. Talk to your healthcare provider about the best way to feed your baby while taking FINTEPLA.

Tell your healthcare provider about all the medicines you take, including prescription and over-the-counter medicines, vitamins, and herbal supplements.

Know the medicines you take. Keep a list of them to show your healthcare provider or pharmacist when you get a new medicine.

How should I take FINTEPLA?

- Read the **Instructions for Use** at the end of this Medication Guide for information on the right way to use FINTEPLA.
- Take FINTEPLA exactly as your healthcare provider tells you to take it.
- Your healthcare provider will tell you how much FINTEPLA to take and when to take it.
- FINTEPLA may be taken with or without food.
- Measure your dose of FINTEPLA using the dosing syringe that is provided by the pharmacy. Do not use a household teaspoon or tablespoon.
- FINTEPLA can be given through gastric and nasogastric feeding tubes

What should I avoid while taking FINTEPLA?

- **Do not** drive, operate heavy machinery, or do other dangerous activities until you know how FINTEPLA affects you. FINTEPLA may cause you to feel sleepy.

What are the possible side effects of FINTEPLA?

FINTEPLA may cause serious side effects, including:

- See “**What is the most important information I should know about FINTEPLA?**”
- **serotonin syndrome**. Serotonin syndrome is a life-threatening problem that can happen in people taking FINTEPLA, especially if FINTEPLA is taken with certain other medicines to include:
 - anti-depressant medicines called SSRIs, SNRIs, TCAs, and MAOIs
 - tryptophan
 - lithium
 - antipsychotics
 - St. John’s Wort
 - dextromethorphan
 - tramadol

Call your healthcare provider right away if you have any of the following symptoms of serotonin syndrome.

- mental status changes such as seeing things that are not there (hallucinations), agitation, or coma
- fast heartbeat
- nausea, vomiting, diarrhea

- changes in blood pressure
- tight muscles
- high body temperature
- trouble walking

- **high blood pressure (hypertension).** Hypertension is both a serious and common side effect. FINTEPLA can cause your blood pressure to increase even if you have never had high blood pressure before. Your healthcare provider will check your blood pressure while you are taking FINTEPLA.
- **increased pressure in your eye (glaucoma).** Symptoms of glaucoma may include:
 - red eyes
 - seeing halos or bright colors around lights
 - nausea or vomiting
 - decreased vision
 - eye pain or discomfort
 - blurred vision

If you have any of these symptoms, call your healthcare provider right away.

The most common side effects of FINTEPLA when used to treat Dravet syndrome (DS) include:

- decreased appetite
- diarrhea
- low energy
- respiratory infection
- decreased weight
- fever
- constipation
- abnormal echocardiogram
- sleepiness
- problems with movement, balance, and walking
- increased drooling
- increased blood pressure
- vomiting
- falls
- seizures that do not stop
- weakness

The most common side effects of FINTEPLA when used to treat Lennox-Gastaut syndrome (LGS) include:

- diarrhea
- tiredness
- vomiting
- sleepiness
- decreased appetite

These are not all the possible side effects of FINTEPLA. For more information, ask your healthcare provider or pharmacist.

Tell your healthcare provider if you have any side effect that bothers you or that does not go away.

Call your doctor for medical advice about side effects. You may report side effects to FDA at 1-800-FDA-1088.

How should I store FINTEPLA?

- Store FINTEPLA at room temperature between 68°F to 77°F (20°C and 25°C).
- **Do not** refrigerate or freeze.
- Store the FINTEPLA bottle and syringe together in a clean area.
- Throw away (discard) any unused FINTEPLA 3 months after first opening the bottle or if the Discard After date on the package or bottle has passed. Whichever one comes first.

Keep FINTEPLA and all medicines out of the reach of children.

General information about the safe and effective use of FINTEPLA.

Medicines are sometimes prescribed for purposes other than those listed in a Medication Guide. Do not use FINTEPLA for a condition for which it was not prescribed. Do not give FINTEPLA to other people, even if they have the same symptoms that you have. It may harm them.

You can ask your pharmacist or healthcare provider for information about FINTEPLA that is written for health professionals.

What are the ingredients in FINTEPLA?

Active ingredient: fenfluramine hydrochloride

Inactive ingredients: cherry flavor, citric acid, ethylparaben, hydroxyethylcellulose, methylparaben, potassium citrate, sucralose, and water.

FINTEPLA contains no ingredient made from gluten-containing grain (wheat, barley, or rye) and contains not more than 0.1% of carbohydrates, which is from the cherry flavoring.

Manufactured for: UCB, Inc., Smyrna, GA 30080

FINTEPLA® is a registered trademark of the UCB Group of Companies. ©2023. All rights reserved.

For more information about FINTEPLA, go to www.fintepla.com or call 1-866-964-3649.

INSTRUCTIONS FOR USE
FINTEPLA® (fin-TEP-la)
(fenfluramine)
oral solution
2.2 mg/mL

Be sure that you read, understand, and follow these instructions before you start using FINTEPLA oral solution and each time you get a refill. There may be new information.

This Instructions for Use contains information on how to take FINTEPLA. This information does not take the place of talking to your healthcare provider about your medical condition or treatment.

What is included with FINTEPLA?

The following items are included to prepare and give an oral dose of FINTEPLA:

- 1 bottle of FINTEPLA oral solution (2.2 mg/mL)
- 2 reusable oral syringes

1 Bottle of FINTEPLA Oral
Solution (2.2 mg/mL)

2 Oral Syringes

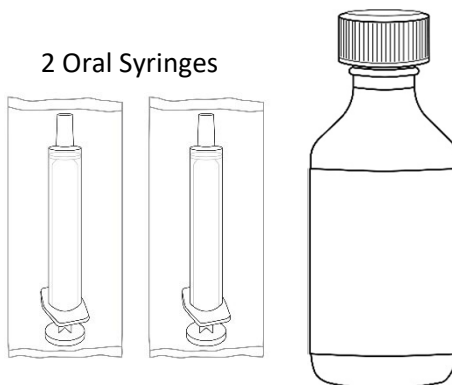

Call the pharmacist at 1-844-288-5007 if you did not receive the items listed above, or if you need help using them.

Important information about FINTEPLA

- FINTEPLA is an **oral** medicine (taken by mouth) and is given **2 times each day**. Follow your healthcare provider's instructions for taking or giving doses of FINTEPLA.
- If you have questions about how to prepare or give FINTEPLA, contact your healthcare provider or call your pharmacist.
- Always use the oral syringes provided with FINTEPLA to make sure the right dose is given. If you need a new syringe contact your pharmacist. **Do not** use a household teaspoon or tablespoon.

Oral syringes provided with FINTEPLA by the pharmacy.

With FINTEPLA you will receive 2 reusable oral syringes.

2 oral syringes that can measure up to 3 mL

OR

2 oral syringes that can measure up to 6 mL

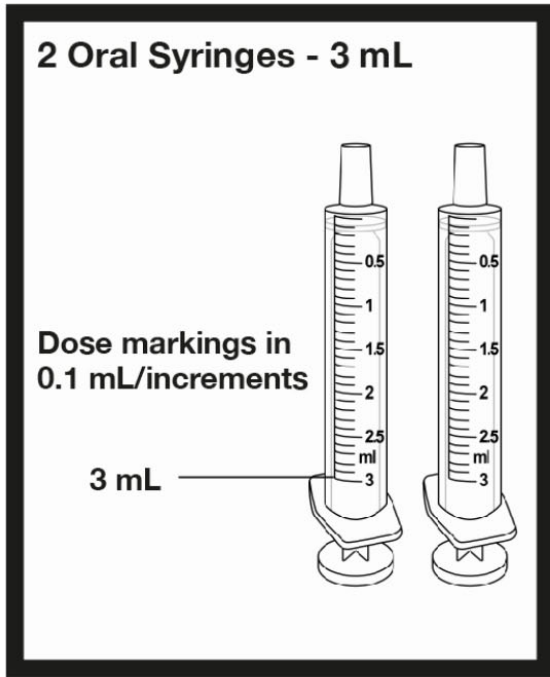

or

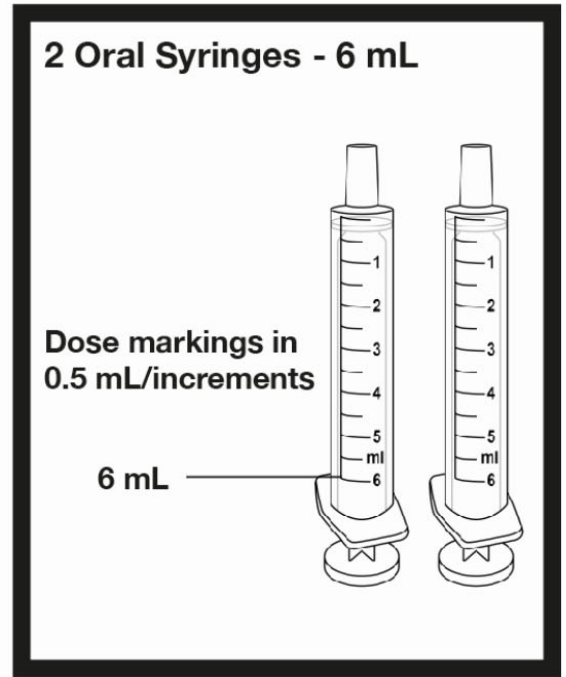

Call the pharmacist at 1-844-288-5007 if you have any questions about the syringes provided with FINTEPLA.

Parts of the Oral Syringe

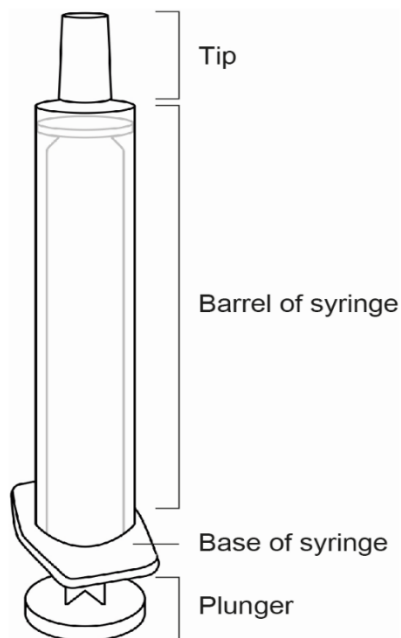

Preparing a Dose

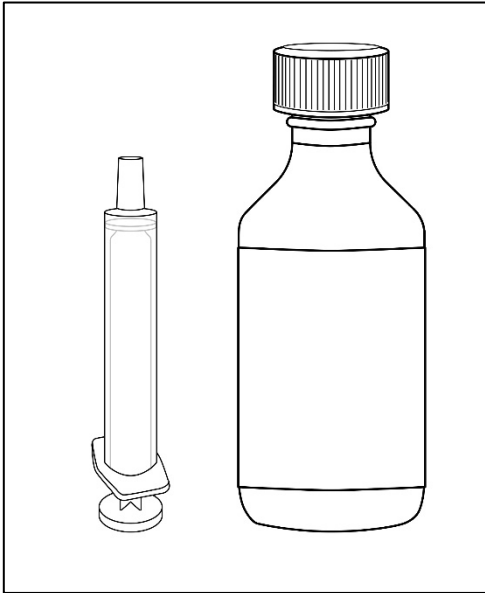

Step 1. Make sure you have:

- The bottle of FINTEPLA oral solution, and
- A clean, dry reusable oral syringe that was provided with FINTEPLA.

Step 2. Check the “Discard After” date (MM/DD/YYYY).

- **Do not** use the medicine if the “Throw Away” (Discard) date has passed.
- If the date is near, contact your pharmacy or healthcare provider to get a refill or new prescription.
- If the date has passed, dispose of any unused FINTEPLA.

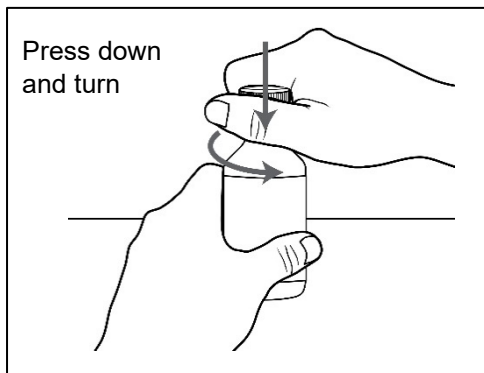

Step 3. Press down and turn the childproof cap to the left (counterclockwise) and remove it from the bottle.

- Set the cap aside (do not throw away).

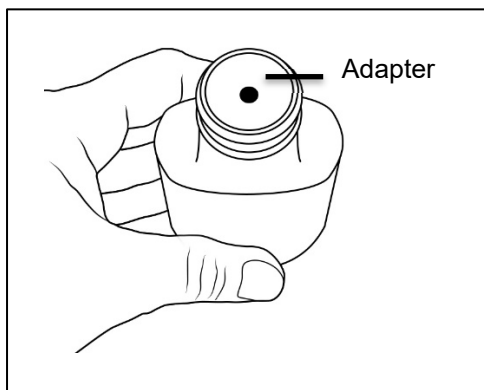

Step 4. Make sure the adapter is on the bottle.

- If the bottle does not have an adapter, contact the pharmacist.
- **Always leave the adapter in place** in the bottle of medicine.

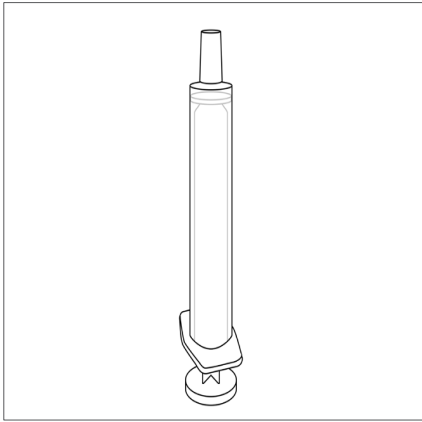

Step 5. Remove an oral syringe from its packaging, if needed.

Only use the oral syringes provided with FINTEPLA.

If an oral syringe is damaged, or you cannot read the dose markings:

- Use the other oral syringe provided, or
- Contact the pharmacist to get a new one.

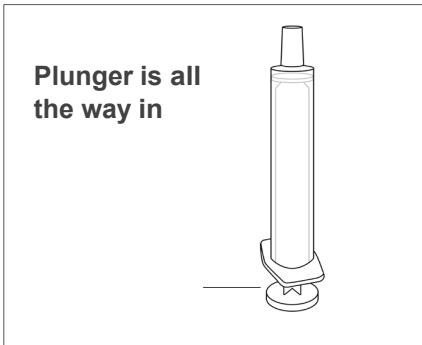

Step 6. Make sure the plunger is pushed all the way into the oral syringe.

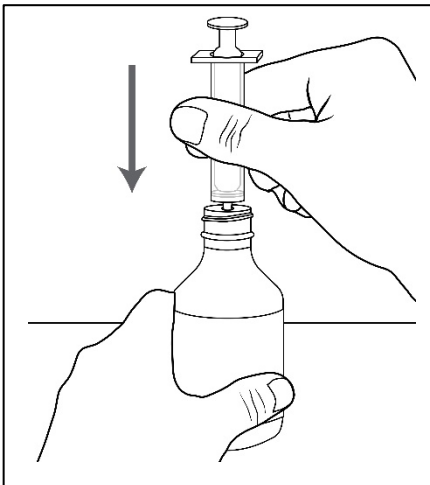

Step 7. Hold the bottle of medicine firmly on a hard, flat surface.

Step 8. Push the tip of the oral syringe into the opening of the adapter until it cannot be pushed further.

Preparing a dose (continued)

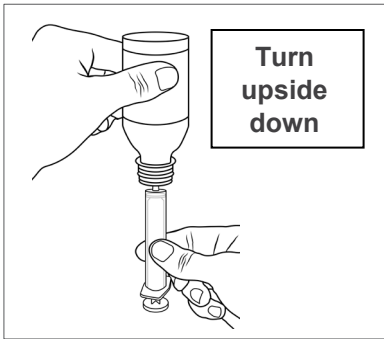

Step 9. Hold the oral syringe and bottle together and turn upside down.

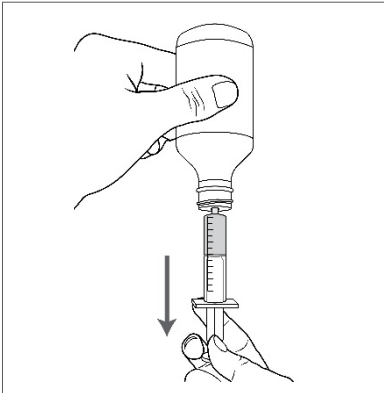

Step 10. Slowly pull the plunger of the oral syringe to withdraw the prescribed dose.

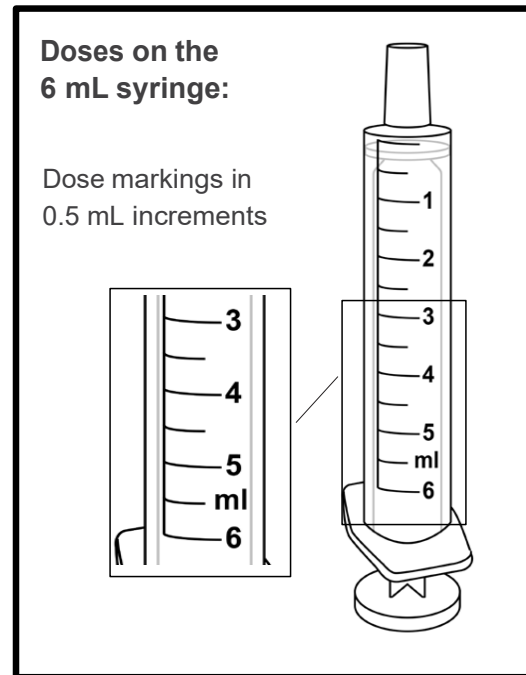
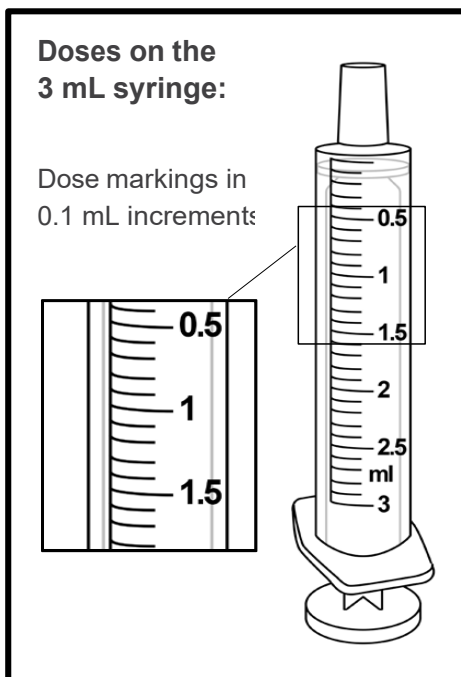

Preparing a dose (continued)

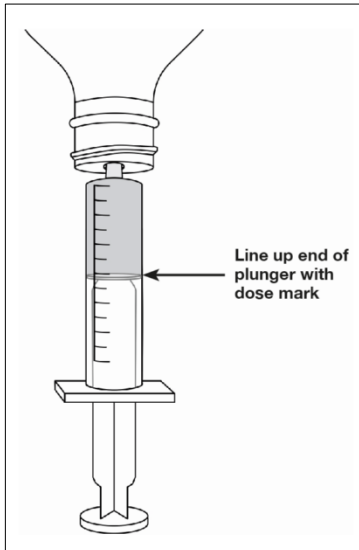

Step 11. Line up the end of the plunger with the mark for the prescribed dose on the oral syringe.

Tips to Getting the Correct Dose

- If you draw out too much medicine:
 - Leave the oral syringe in the adapter.
 - Push the plunger slowly back into the syringe until you reach the prescribed dose.
- If you see air bubbles in the medicine:
 - Leave the oral syringe in the adapter.
 - Pull the plunger further down.
 - Allow the bubbles to rise to the tip of the syringe.
 - Push the plunger in all the way.
 - **Slowly** pull the plunger out to the prescribed dose.

Note: Very small bubbles in the liquid are normal.

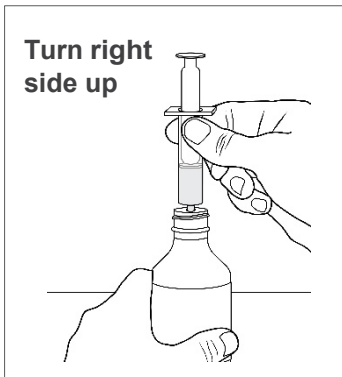

Step 12. Hold the oral syringe and bottle together and then turn the bottle right side up.

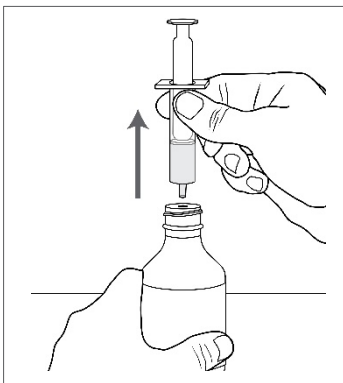

Step 13. Holding the bottle firmly, gently pull the oral syringe out of the bottle adapter.

Step 14. Make sure the dose in the oral syringe still matches the prescribed dose.

If the dose does not match:

- Put the syringe back into adapter.
- See steps 9 to 11 to adjust the dose, as needed.

Giving FINTEPLA

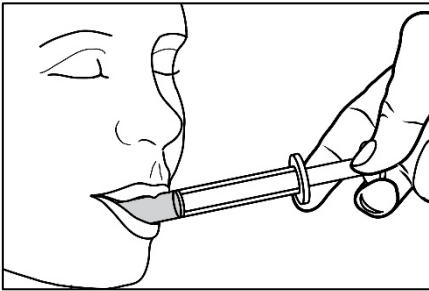

Step 15. Place the tip of the oral syringe against the inside of the cheek.

Step 16. Gently push the plunger in until all the medicine in the oral syringe is given.

- **Do not** squirt or forcefully push the medicine into the back of the throat. This may cause choking.

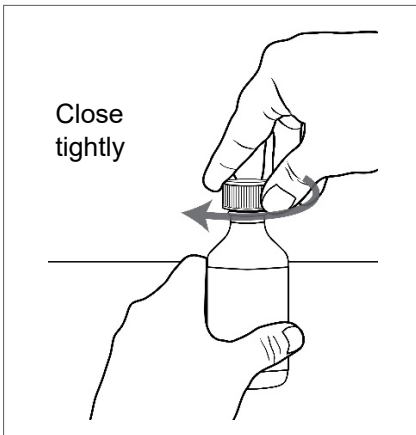

Step 17. Place the cap back on the bottle tightly by turning the cap right (clockwise) until it stops.

- Always leave the adapter in place in the bottle
- The cap will fit over it.

Cleaning the syringe

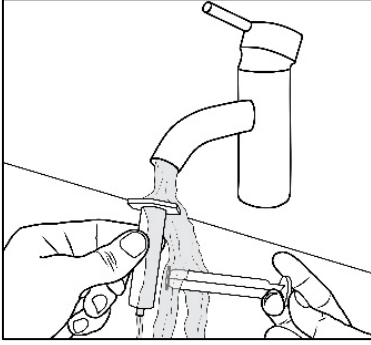

- Rinse the oral syringe with clean tap water and allow it to air dry after each use.
- Make sure you rinse the inside of the syringe and the plunger.

Cleaning Tips:

- Pull clean tap water into the syringe with the plunger and push it out several times to clean the syringe.
- Remove the plunger from the barrel of the oral syringe
- Rinse both parts under tap water
- Make sure the syringe and plunger are completely dry before the next use.
- The syringe is also safe to clean in the dishwasher.

How should I store FINTEPLA?

- Store FINTEPLA at room temperature between 68°F to 77°F (20°C to 25°C).
- **Do not** refrigerate or freeze.
- Keep the cap tightly closed and the bottle upright.
- Store the FINTEPLA bottle and syringe together in a clean area.
- Throw away (discard) any unused FINTEPLA 3 months after first opening the bottle **or** if the Discard After date on the package or bottle has passed. Whichever one comes first.
- **Keep FINTEPLA and all medicines out of the reach of children.**

Manufactured for: UCB, Inc., Smyrna, GA 30080

FINTEPLA® is a registered trademark of the UCB Group of Companies. ©2023. All rights reserved.

This Instructions for Use has been approved by the U.S. Food and Drug Administration.

Revised: 3/2023